

Article number: 0101032
 Description: Retaining ring A 16 DIN 471
 Spring steel
 Note: Fitted with ZGA pilers

Measures

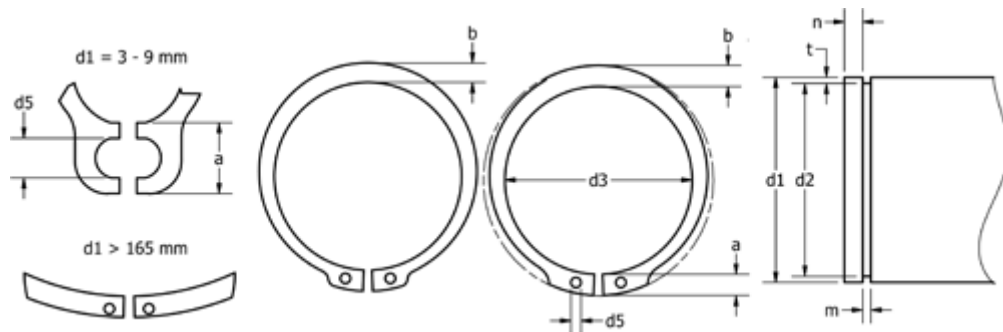

a max	= 3.7	FN kN	= 3.2	s	= 1.00
AN mm ²	= 19.6	FRg kN	= 2.40	t	= 0.40
b	= 2.2	FR kN	= 7.40	tol	= -0.11
d1	= 16	g	= 1.0	tol	= -0.06
d2	= 15.2	K kN-mm	= 21.00	tol	= +0,10-0,36
d3	= 14.7	m min	= 1.10	Tong	= ZGA-1
d5 min	= 1.7	n abl x 1000	= 45.0	Weight kg/1000	= 0.700
Description	= A16	Nominal drive	= 1.2		